

VARIOLINE *Wood Diagonal*



- VARIOLINE Wood Diagonal is a range of printed mineral ceilings that provides the appearance and warmth of wood
- Contemporary and innovative wood design options with diagonal print
- Perfect playground to create aesthetically pleasing, well-designed rooms
- Choice of 6 different wood species in both light and dark tones for design flexibility
- The laminated acoustic surface provides up to Class A sound absorption
- Ideal for offices, foyers, as well as retail and entertainment spaces
- More design choice, additional capability with multi-material solutions

Build on us.



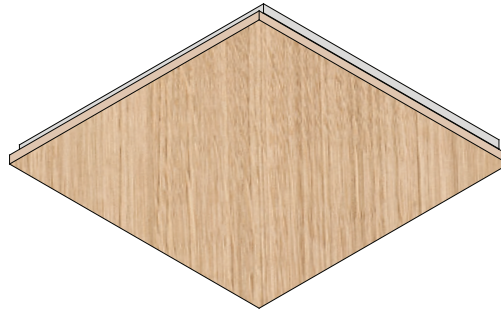

Oak. Other colours available on request

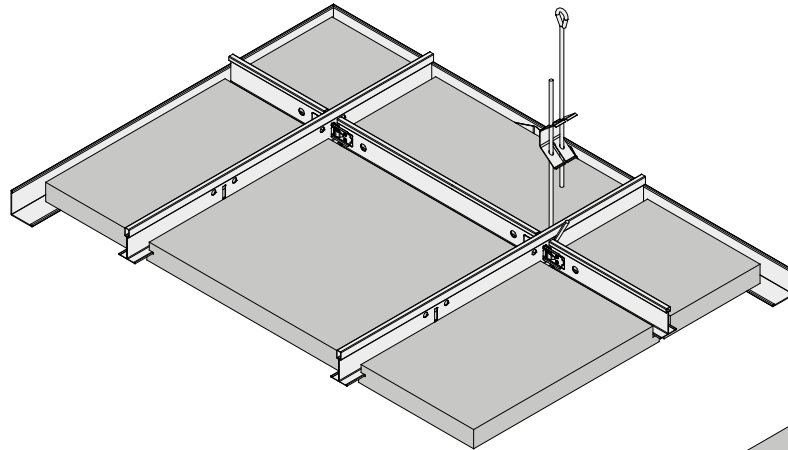

**VARIOLINE
Wood Diagonal (dB)**

Vector

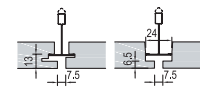

24

600 x 600
625 x 625

Semi-concealed tiles,
demountable - System C

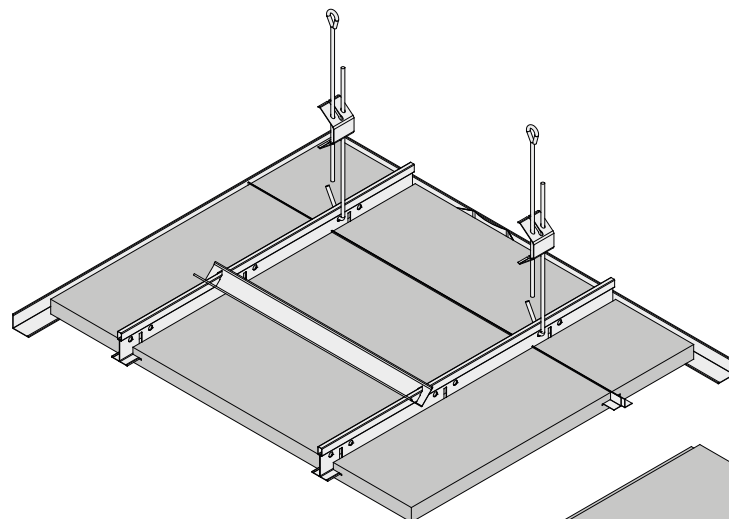
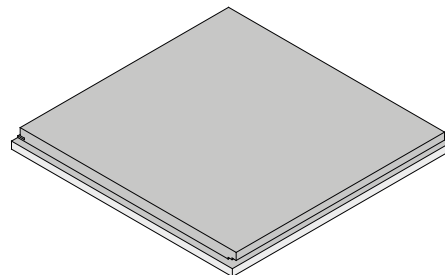

**VARIOLINE
Wood Diagonal (HD)**

Finesse

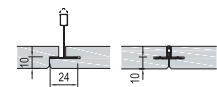

19

600 x 600
625 x 625

Concealed, demountable -
System A.2 / A.3

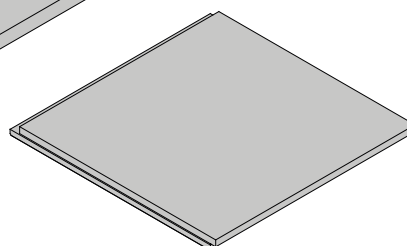

Put your imagination to the test: be playful and inventive with our printed wood tones to create truly bespoke motifs.

Single tone layout

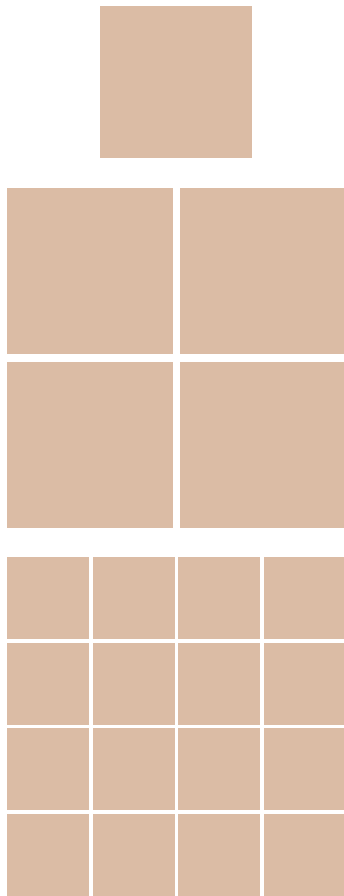

Two tone grain layout 50/50

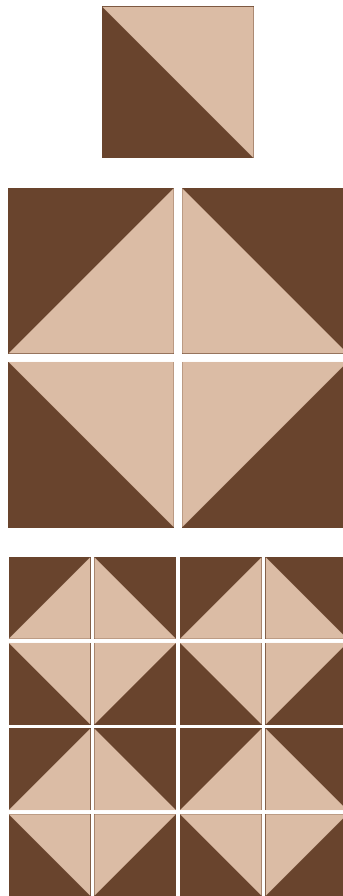



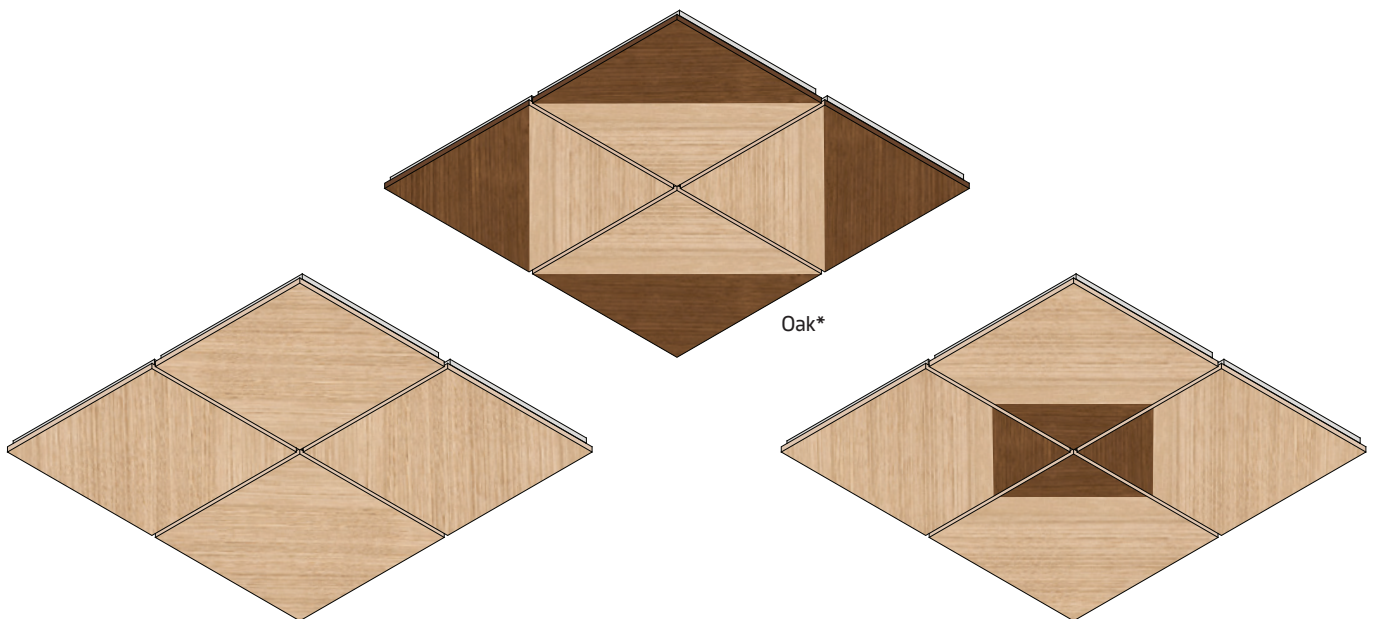
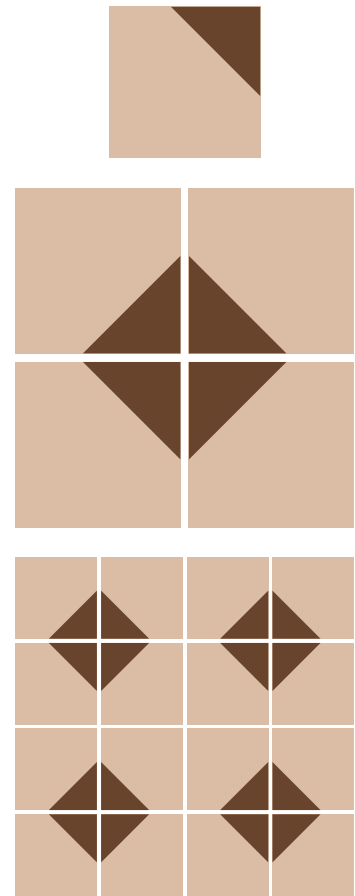







Two tone grain layout 25/75

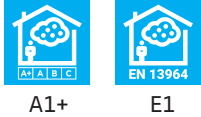

*Other colours available on request. **Please note that special installation instructions are provided for the "diamond" pattern.**

The image is not to scale. It is only for illustrative purposes.
Product availability may vary from country to country. Please contact your local sales representative.
For further information and legal notice, please visit our website.

Characteristic	Detailed information																						
Colour		 <p>Oak Ash Walnut Cherry Larch Bamboo</p> <p>Other colours available on request.</p>																					
Weight		5.2 kg/m ² (Finesse) 8.6 kg/m ² (Vector)																					
Sound absorption		EN ISO 354 $\alpha_w = 0.65$ (H) (Vector, SL2) as per EN ISO 11654 - Class C $\alpha_w = 0.90$ (H) (Finesse) as per EN ISO 11654 - Class A <table border="1" data-bbox="437 763 1477 853"> <thead> <tr> <th>Frequency f (Hz)</th> <th>125</th> <th>250</th> <th>500</th> <th>1000</th> <th>2000</th> <th>4000</th> </tr> </thead> <tbody> <tr> <td>α_p Vector</td> <td>0.45</td> <td>0.40</td> <td>0.60</td> <td>0.80</td> <td>0.95</td> <td>1.00</td> </tr> <tr> <td>α_p Finesse</td> <td>0.50</td> <td>0.70</td> <td>0.80</td> <td>0.90</td> <td>1.00</td> <td>1.00</td> </tr> </tbody> </table> NRC = 0.70 (Vector) as per ASTM C 423 NRC = 0.85 (Finesse) as per ASTM C 423	Frequency f (Hz)	125	250	500	1000	2000	4000	α_p Vector	0.45	0.40	0.60	0.80	0.95	1.00	α_p Finesse	0.50	0.70	0.80	0.90	1.00	1.00
Frequency f (Hz)	125	250	500	1000	2000	4000																	
α_p Vector	0.45	0.40	0.60	0.80	0.95	1.00																	
α_p Finesse	0.50	0.70	0.80	0.90	1.00	1.00																	
Sound attenuation		$D_{n,f,w} = 34$ dB (Finesse) as per EN ISO 717-1 $D_{n,f,w} = 38$ dB (Vector) as per EN ISO 717-1 $CAC = 35$ dB (Finesse) as per ASTM E 413-10 $CAC = 39$ dB (Vector) as per ASTM E 413-10																					
Fire reaction		Euroclass A2-s1, d0 as per EN 13501-1 for light versions (excl. Walnut) Euroclass C-s1, d0 for some specific dark versions																					
Humidity resistance		95% RH																					
Air permeability		PM1 (≤ 30 m ³ /hm ²) as per DIN 18177																					
Indoor air quality		 <p>A1+ E1</p>																					
Sustainability		49,3 % (2024)																					
Cleanability	